

WE BREATHE FASTENERS®

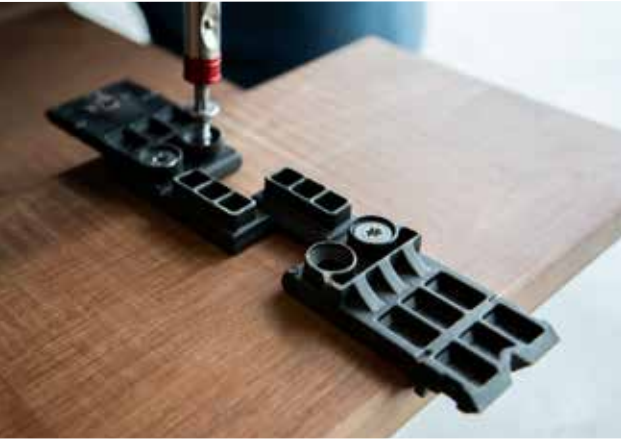

pgb-Europe is a total supplier of fastening systems and hand tools. With our broad and deep product range, we offer our customers a total solution.

www.pgb-europe.com

 **HAPAX®**

Quality by **pgb**

Work strong with the full Hapax range

“ A complete quality range
for the professional who knows what he wants ! ”



5

Hapax wood screws



8

L-Boxx



25

Fixing Pro



29

D-Pro



35

Atlas Decking support



39

Hapax Rock



42

Tools



48

Wedges



53

Retail solutions

“The wide Hapax range is manufactured according to the highest quality standards !”



You do not have to look for reasons why the Hapax wood screw is so popular with professionals. They owe their popularity, to a lower screw-in torque combined with a high screw-in speed. These quality and patented wood screws are designed by pgb-Europe. Based on years of experience, they are produced and packed under strict quality requirements.

Working with Hapax wood screws means saving time!

“The Hapax wood screw is innovative and reliable.”

Get to know the Hapax wood screw



Patented and unique “triple thread point”

What makes these screws unique is the patented triple thread point and the patented unique design of the countersunk milling grooves under the head.

The triple thread point ensures that the screw quickly grips the wood and is powerfully screwed in. This makes the screw very suitable for use in demanding applications while reducing the risk of splitting the wood to a minimum.

Easier working with the Hapax wood screw

The specially shaped milling ribs under the head smoothly sink into the wood and stop on metal without damaging the surface. An optimised thread ensures a low tightening torque without compromising the high pull-out value.

With the Hapax screws you have a number of strong advantages: a solid, high-quality fastening and you are able to save some time!

The 6 advantages of the Hapax wood screw:

- CE / ETA certified to the highest standards.
- Unique and patented design.
- Installation right up to the edge of the wood without the risk of splitting.
- Energy-saving and less stressful work.
- Save time thanks to quick turn-in.
- Environmental friendly coating.



The Hapax wood screw: the ideal screw for every situation



Clear packaging

To keep the merchandising presentation simple and clear, Hapax works with 3 clear colour codes:

Universal screws

Construction screws

Terrace screws

European Technical Assessment

The Hapax wood screws have recently passed the ETA test for which they have received the ETA assessment. The ETA is available starting from diameter 3mm ranging up to diameter 8mm.

In addition, they also carry the previously obtained CE mark.



Stick-fit tx recess

- Excellent fit of the bit.
- Prevents damage to the coating of the screw.
- Free bit in the packaging.



Multi-functional milling ribs under the head

- Specially shaped milling ribs sink into wood and brake on metal without damaging the surface.
- Suitable for wood and metal.



Routing ridges on the shank

- Reduces the tension on the shaft and head of the screw.
- Extends the battery life of your electric screwdriver.
- For screw lengths from 90 mm.



Optimised thread

- Faster threading.
- High pull-out values for a secure connection.
- Special synthetic coating reduces the screw-in moment.



Sawtooth thread

- Cutters in the thread help to cut through the wood fibres.
- For screw lengths from 55 mm.



Patented 'triple thread point'

- Drastically reduces splitting of the wood, even in delicate applications.
- Thread right up to the tip ensures rapid engagement.

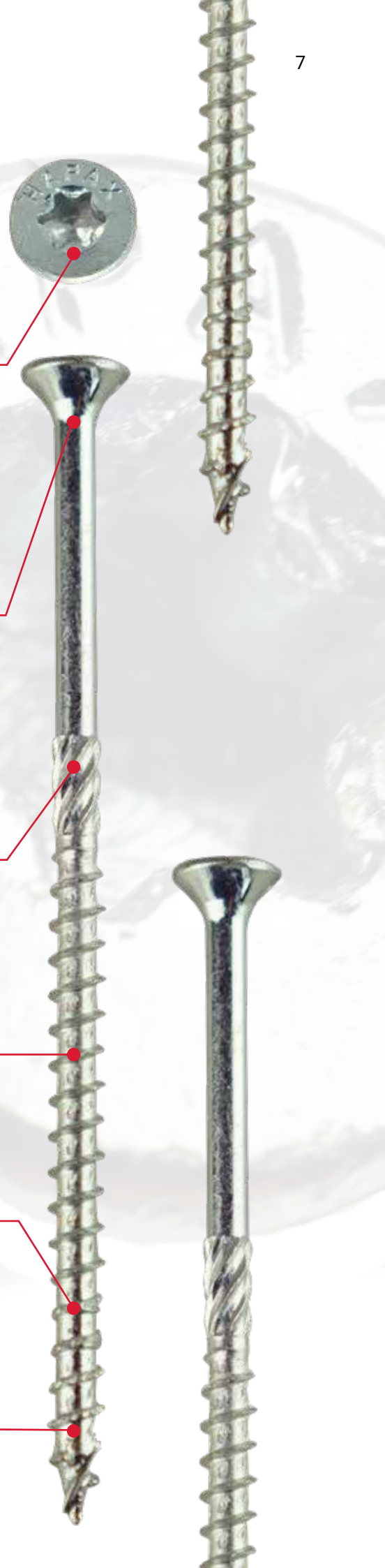
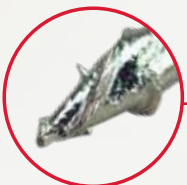

BlueTop coating: quality for a lifetime

“BlueTop coating offers greater resistance to corrosion.”



This high quality screw is further upgraded with a unique BlueTop coating. The BlueTop coating offers up to 10 times more resistance to corrosion in a neutral salt spray test than conventional galvanisation. This makes the screw ideal for use in open constructions without direct exposure to the elements, such as carports or roof constructions.

REACH / ROHS conformity

As a result, the screws meet the requirements of service class II according to Eurocode 5. The BlueTop coating is free of chromium VI and meets all the requirements of REACH / ROHS. This ensures that the environmental impact during production and recycling is reduced to a minimum.

Organised and safe with the Hapax L-Boxx

The Hapax L-Boxx is a real must-have for every professional. A complete screw set of 15 different sizes (bits included) with the advantages of the handy L-Boxx case. This innovative storage system is 100% compatible with every Sortimo® in-vehicle equipment and ensures that you always have all of your wood screws easily at hand.

Innovative click system

With the innovative click system, you can connect several L-Boxxes together and have a neat and tidy collection of screws. This product is also compatible with the storage system in your van, allowing you to create a well-organised van while travelling safely.

“A real must-have for every professional who wants to organise his van !”



HAWVTV

Universal woodscrew with full thread and countersunk head

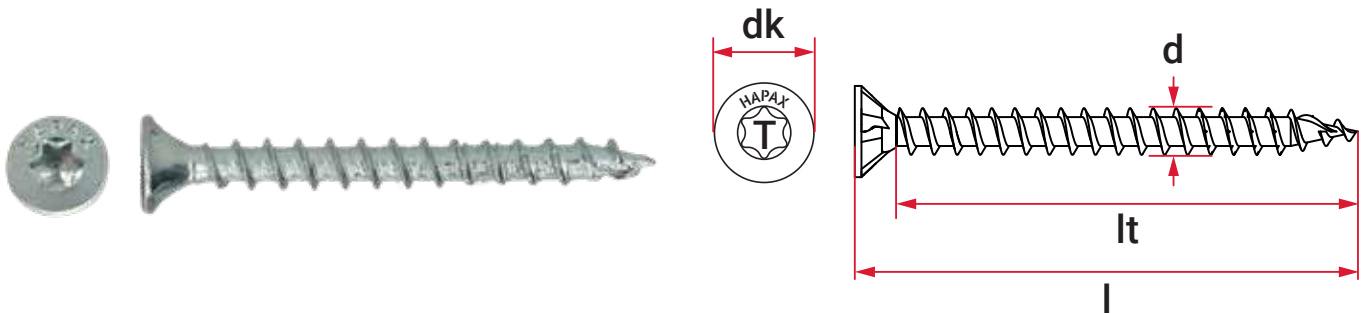

ETA 20/0787 - Screws for use in timber construction
DoPn° - 20-0787-01



Art. ref.	EAN code	d [mm]	l [mm]	lt [mm]	dk [mm]	Recess type	pcs / Box	pcs / Outer carton	pcs / Pallet
HAWVTV001002500123	5410439011853	2,5	12	10	5,1	T 8	200	28800	691200
HAWVTV001002500163	5410439011860	2,5	16	14	5,1	T 8	200	28800	691200
HAWVTV001002500203	5410439011877	2,5	20	17	5,1	T 8	200	28800	691200
HAWVTV001003000123	5410439011884	3	12	10	6	T 10	200	28800	691200
HAWVTV001003000163	5410439011891	3	16	14	6	T 10	200	28800	691200
HAWVTV001003000203	5410439011907	3	20	17	6	T 10	200	16000	384000
HAWVTV001003000253	5410439011914	3	25	21	6	T 10	200	16000	384000
HAWVTV001003000303	5410439011921	3	30	26	6	T 10	200	12000	288000
HAWVTV001003000353	5410439011938	3	35	31	6	T 10	200	12000	288000
HAWVTV001003000403	5410439011945	3	40	36	6	T 10	200	9600	230400
HAWVTV001003500123	5410439012058	3,5	12	8	7	T 15	200	28800	691200
HAWVTV001003500163	5410439012065	3,5	16	12	7	T 15	200	28800	691200
HAWVTV001003500203	5410439012072	3,5	20	16	7	T 15	200	16000	384000
HAWVTV001003500253	5410439012089	3,5	25	21	7	T 15	200	16000	384000
HAWVTV001003500303	5410439012133	3,5	30	25	7	T 15	200	12000	288000
HAWVTV001003500353	5410439012140	3,5	35	30	7	T 15	200	12000	288000
HAWVTV001003500403	5410439012157	3,5	40	35	7	T 15	200	7200	172800
HAWVTV001003500453	5410439012164	3,5	45	40	7	T 15	200	7200	172800
HAWVTV001003500503	5410439012171	3,5	50	45	7	T 15	200	7200	172800
HAWVTV001004000123	5410439012188	4	12	8	8	T 20	200	28800	691200
HAWVTV001004000163	5410439012195	4	16	12	8	T 20	200	16000	384000
HAWVTV001004000203	5410439012218	4	20	16	8	T 20	200	16000	384000
HAWVTV001004000253	5410439012225	4	25	21	8	T 20	200	12000	288000
HAWVTV001004000303	5410439012232	4	30	25	8	T 20	200	12000	288000
HAWVTV001004000353	5410439012256	4	35	30	8	T 20	200	9600	230400
HAWVTV001004000403	5410439012263	4	40	35	8	T 20	200	7200	172800
HAWVTV001004000453	5410439012621	4	45	40	8	T 20	200	7200	172800
HAWVTV001004000503	5410439012270	4	50	45	8	T 20	200	7200	172800

Art. ref.	EAN code	d [mm]	l [mm]	lt [mm]	dk [mm]	Recess type	pcs / Box	pcs / Outer carton	pcs / Pallet
HAWVTV001004000603	5410439012287	4	60	50	8	T 20	200	4800	115200
HAWVTV001004500163	5410439012294	4,5	16	11	8,8	T 20	200	16000	384000
HAWVTV001004500203	5410439012300	4,5	20	15	8,8	T 20	200	12000	288000
HAWVTV001004500253	5410439012317	4,5	25	20	8,8	T 20	200	12000	288000
HAWVTV001004500303	5410439012690	4,5	30	25	8,8	T 20	200	9600	230400
HAWVTV001004500353	5410439012324	4,5	35	30	8,8	T 20	200	7200	172800
HAWVTV001004500403	5410439012331	4,5	40	34	8,8	T 20	200	7200	172800
HAWVTV001004500453	5410439012348	4,5	45	39	8,8	T 20	200	4800	115200
HAWVTV001004500503	5410439012355	4,5	50	44	8,8	T 20	200	4800	115200
HAWVTV001004500603	5410439012362	4,5	60	54	8,8	T 20	200	3200	76800
HAWVTV001005000163	5410439012379	5	16	11	9,7	T 25	200	12000	288000
HAWVTV001005000203	5410439012386	5	20	15	9,7	T 25	200	9600	230400
HAWVTV001005000253	5410439012393	5	25	20	9,7	T 25	200	9600	230400
HAWVTV001005000303	5410439012409	5	30	25	9,7	T 25	200	7200	172800
HAWVTV001005000353	5410439012416	5	35	30	9,7	T 25	200	7200	172800
HAWVTV001005000403	5410439013062	5	40	35	9,7	T 25	200	7200	172800
HAWVTV001005000453	5410439013086	5	45	39	9,7	T 25	200	4800	115200
HAWVTV001005000503	5410439012423	5	50	44	9,7	T 25	200	4800	115200
HAWVTV001005000603	5410439012430	5	60	54	9,7	T 25	200	3200	76800
HAWVTV001005000703	5410439012447	5	70	61	9,7	T 25	200	2400	57600
HAWVTV001006000303	5410439012454	6	30	24	11,6	T 30	200	7200	172800
HAWVTV001006000403	5410439012461	6	40	34	11,6	T 30	200	4800	115200
HAWVTV001006000453	5410439012478	6	45	38	11,6	T 30	200	3200	76800
HAWVTV001006000503	5410439012485	6	50	43	11,6	T 30	200	3200	76800
HAWVTV001006000603	5410439012492	6	60	53	11,6	T 30	200	2400	57600
HAWVTV001006000703	5410439012508	6	70	61	11,6	T 30	200	2400	57600

HAWVTG

Universal woodscrew with partial thread and countersunk head

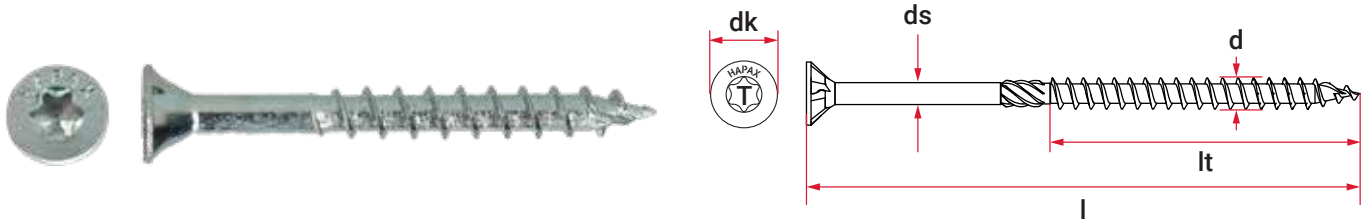

ETA 20/0787 - Screws for use in timber construction
DoPn° - 20-0787-01



Art. ref.	EAN code	d [mm]	l [mm]	lt [mm]	dk [mm]	Recess type	pcs / Box	pcs / Outer carton	pcs / Pallet
HAWVTG001003000253	5410439010030	3	25	18	6	T 10	200	16000	384000
HAWVTG001003000303	5410439010047	3	30	18	6	T 10	200	12000	288000
HAWVTG001003000353	5410439010054	3	35	23	6	T 10	200	12000	288000
HAWVTG001003000403	5410439010061	3	40	23	6	T 10	200	9600	230400
HAWVTG001003500253	5410439010078	3,5	25	18	7	T 15	200	16000	384000
HAWVTG001003500303	5410439010085	3,5	30	18	7	T 15	200	12000	288000
HAWVTG001003500353	5410439010092	3,5	35	23	7	T 15	200	12000	288000
HAWVTG001003500403	5410439010108	3,5	40	23	7	T 15	200	7200	172800
HAWVTG001003500453	5410439010115	3,5	45	30	7	T 15	200	7200	172800
HAWVTG001003500503	5410439010122	3,5	50	32	7	T 15	200	7200	172800
HAWVTG001004000303	5410439010139	4	30	18	8	T 20	200	12000	288000
HAWVTG001004000353	5410439010337	4	35	23	8	T 20	200	9600	230400
HAWVTG001004000403	5410439010146	4	40	23	8	T 20	200	7200	172800
HAWVTG001004000453	5410439010153	4	45	30	8	T 20	200	7200	172800
HAWVTG001004000503	5410439010160	4	50	32,5	8	T 20	200	7200	172800
HAWVTG001004000603	5410439010177	4	60	35	8	T 20	200	4800	115200
HAWVTG001004000703	5410439010184	4	70	37,5	8	T 20	200	3200	76800
HAWVTG001004500303	5410439010191	4,5	30	20	8,8	T 20	200	9600	230400
HAWVTG001004500353	5410439010207	4,5	35	25	8,8	T 20	200	7200	172800
HAWVTG001004500403	5410439010214	4,5	40	25	8,8	T 20	200	7200	172800
HAWVTG001004500453	5410439010443	4,5	45	30	8,8	T 20	200	4800	115200
HAWVTG001004500503	5410439010474	4,5	50	32,5	8,8	T 20	200	4800	115200
HAWVTG001004500603	5410439010481	4,5	60	37	8,8	T 20	200	3200	76800
HAWVTG001004500703	5410439010498	4,5	70	42	8,8	T 20	200	3200	76800
HAWVTG001004500803	5410439010504	4,5	80	47	8,8	T 20	200	3200	76800
HAWVTG001005000403	5410439010528	5	40	27	9,7	T 25	200	7200	172800
HAWVTG001005000453	5410439010573	5	45	30	9,7	T 25	200	4800	115200
HAWVTG001005000503	5410439010610	5	50	32	9,7	T 25	200	4800	115200

Art. ref.	EAN code	d [mm]	l [mm]	lt [mm]	dk [mm]	Recess type	pcs / Box	pcs / Outer carton	pcs / Pallet
HAWVTG001005000603	5410439010627	5	60	37	9,7	T 25	200	3200	76800
HAWVTG001005000703	5410439010665	5	70	41	9,7	T 25	200	2400	57600
HAWVTG001005000803	5410439010672	5	80	46	9,7	T 25	200	2400	57600
HAWVTG001005000903	5410439010689	5	90	61	9,7	T 25	200	2400	57600
HAWVTG001005001003	5410439010726	5	100	61	9,7	T 25	200	1600	38400
HAWVTG001005001203	5410439010733	5	120	69	9,7	T 25	200	1600	38400
HAWVTG001006000603	5410439011693	6	60	37	11,6	T 30	200	2400	57600
HAWVTG001006000703	5410439010757	6	70	41	11,6	T 30	200	2400	57600
HAWVTG001006000803	5410439010795	6	80	46	11,6	T 30	200	2400	57600
HAWVTG001006000903	5410439010801	6	90	61	11,6	T 30	200	1600	38400
HAWVTG001006001003	5410439010825	6	100	61	11,6	T 30	100	1600	38400
HAWVTG001006001103	5410439010870	6	110	68	11,6	T 30	100	1600	38400
HAWVTG001006001203	5410439010887	6	120	68	11,6	T 30	100	1200	28800
HAWVTG001006001303	5410439010894	6	130	68	11,6	T 30	100	1200	28800
HAWVTG001006001403	5410439010900	6	140	68	11,6	T 30	100	1200	28800
HAWVTG001006001503	5410439010924	6	150	68	11,6	T 30	100	1200	28800
HAWVTG001006001603	5410439010993	6	160	68	11,6	T 30	100	1200	28800
HAWVTG001006001803	5410439011402	6	180	68	11,6	T 30	100	800	19200
HAWVTG001006002003	5410439011457	6	200	68	11,6	T 30	100	800	19200

HA EVTG

The wood construction screw with partial thread and countersunk head

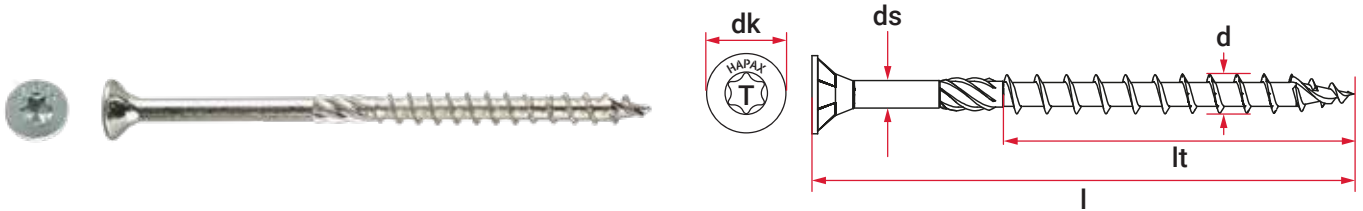

ETA 20/0787 - Screws for use in timber construction
DoPn° - 20-0787-01



Art. ref.	EAN code	d [mm]	l [mm]	lt [mm]	dk [mm]	Recess type	pcs / Box	pcs / Outer carton	pcs / Pallet
HAEVTG001005000403	5410439472517	5	40	24	10	T 25	200	7200	172800
HAEVTG001005000503	5410439472524	5	50	30	10	T 25	200	4800	115200
HAEVTG001005000603	5410439472531	5	60	36	10	T 25	200	3200	76800
HAEVTG001005000703	5410439472548	5	70	42	10	T 25	200	2400	57600
HAEVTG001005000803	5410439472555	5	80	48	10	T 25	200	2400	57600
HAEVTG001005000903	5410439472562	5	90	54	10	T 25	200	2400	57600
HAEVTG001005001003	5410439472579	5	100	60	10	T 25	200	1600	38400
HAEVTG001005001203	5410439472586	5	120	70	10	T 25	200	1600	38400
HAEVTG001006000603	5410439472593	6	60	36	12	T 30	200	2400	57600
HAEVTG001006000703	5410439472609	6	70	42	12	T 30	200	1600	38400
HAEVTG001006000803	5410439472616	6	80	48	12	T 30	200	1600	38400
HAEVTG001006000903	5410439472623	6	90	54	12	T 30	200	1600	38400
HAEVTG001006001003	5410439472630	6	100	60	12	T 30	100	1600	38400
HAEVTG001006001203	5410439472647	6	120	75	12	T 30	100	1200	28800
HAEVTG001006001403	5410439472654	6	140	80	12	T 30	100	1200	28800
HAEVTG001006001603	5410439472661	6	160	90	12	T 30	100	1200	28800
HAEVTG001006001803	5410439472678	6	180	100	12	T 30	100	800	19200
HAEVTG001006002003	5410439472685	6	200	100	12	T 30	100	800	19200
HAEVTG001006002103	5410439472692	6	210	100	12	T 30	100	800	19200
HAEVTG001006002203	5410439472708	6	220	100	12	T 30	100	800	19200
HAEVTG001006002303	5410439472715	6	230	100	12	T 30	100	800	19200
HAEVTG001006002403	5410439472722	6	240	100	12	T 30	100	800	19200
HAEVTG001006002603	5410439472739	6	260	100	12	T 30	100	400	9600
HAEVTG001006002803	5410439472746	6	280	100	12	T 30	100	400	14400
HAEVTG001006003003	5410439472753	6	300	100	12	T 30	100	400	9600
HAEVTG001008000803	5410439472760	8	80	48	14,5	T 40	50	800	19200
HAEVTG001008001003	5410439472777	8	100	60	14,5	T 40	50	800	19200
HAEVTG001008001203	5410439472784	8	120	75	14,5	T 40	50	600	14400

Art. ref.	EAN code	d [mm]	l [mm]	lt [mm]	dk [mm]	Recess type	pcs / Box	pcs / Outer carton	pcs / Pallet
HAEVTG001008001403	5410439472791	8	140	80	14,5	T 40	50	600	14400
HAEVTG001008001603	5410439472807	8	160	90	14,5	T 40	50	600	14400
HAEVTG001008001803	5410439472814	8	180	100	14,5	T 40	50	400	9600
HAEVTG001008002003	5410439472821	8	200	100	14,5	T 40	50	400	9600
HAEVTG001008002203	5410439472838	8	220	100	14,5	T 40	50	400	9600
HAEVTG001008002403	5410439472845	8	240	100	14,5	T 40	50	400	9600
HAEVTG001008002603	5410439472852	8	260	100	14,5	T 40	50	200	4800
HAEVTG001008002803	5410439472869	8	280	100	14,5	T 40	50	200	4800
HAEVTG001008003003	5410439472876	8	300	100	14,5	T 40	50	200	4800
HAEVTG001008003203	5410439472883	8	320	100	14,5	T 40	50	200	4800
HAEVTG001008003403	5410439472890	8	340	100	14,5	T 40	50		5400
HAEVTG001008003603	5410439472906	8	360	100	14,5	T 40	50		5400
HAEVTG001008003803	5410439472913	8	380	100	14,5	T 40	50		5400
HAEVTG001008004003	5410439472920	8	400	100	14,5	T 40	50		5400
HAEVTG001008004403	5410439472937	8	440	100	14,5	T 40	50		5400
HAEVTG001010001003	5410439472944	10	100	60	18	T 40	50	600	14400
HAEVTG001010001203	5410439472951	10	120	75	18	T 40	50	600	14400
HAEVTG001010001403	5410439472968	10	140	80	18	T 40	50	600	14400
HAEVTG001010001603	5410439299336	10	160	90	18	T 40	50	600	14400
HAEVTG001010001803	5410439472975	10	180	100	18	T 40	50	400	9600
HAEVTG001010002003	5410439472982	10	200	100	18	T 40	50	400	9600
HAEVTG001010002203	5410439472999	10	220	100	18	T 40	50	400	9600
HAEVTG001010002403	5410439473002	10	240	100	18	T 40	50	300	7200
HAEVTG001010002603	5410439473019	10	260	100	18	T 40	50		6150
HAEVTG001010002803	5410439473026	10	280	100	18	T 40	50		6150
HAEVTG001010003003	5410439473033	10	300	100	18	T 40	25	150	3600
HAEVTG001010003203	5410439473040	10	320	100	18	T 40	25	150	3600
HAEVTG001010003403	5410439473057	10	340	100	18	T 40	25	150	3600
HAEVTG001010003603	5410439473064	10	360	100	18	T 40	25		2700
HAEVTG001010003803	5410439473071	10	380	100	18	T 40	25		2700
HAEVTG001010004003	5410439473088	10	400	100	18	T 40	25		2550
HAEVTG001010004403	5410439473095	10	440	100	18	T 40	25		2550
HAEVTG001012002203	5410439473101	12	220	100	20		50	300	7200
HAEVTG001012002403	5410439473118	12	240	100	20		50	300	7200
HAEVTG001012002803	5410439473125	12	280	100	20		50	300	7200
HAEVTG001012003003	5410439473132	12	300	100	20		50	300	7200
HAEVTG001012003203	5410439473149	12	320	100	20		50	300	7200
HAEVTG001012003403	5410439473156	12	340	100	20		50	300	7200
HAEVTG001012003603	5410439473163	12	360	100	20		50	300	7200
HAEVTG001012004003	5410439473170	12	400	100	20		50	300	7200
HAEVTG001012004403	5410439473187	12	440	100	20		50	300	7200
HAEVTG001012004803	5410439473194	12	480	100	20		50	300	7200
HAEVTG001012005203	5410439473200	12	520	100	20		50	300	7200
HAEVTG001012005603	5410439473217	12	560	100	20		50	300	7200
HAEVTG001012006003	5410439473224	12	600	100	20		50	300	7200

HAETTG

The wood construction screw with partial thread and flange head

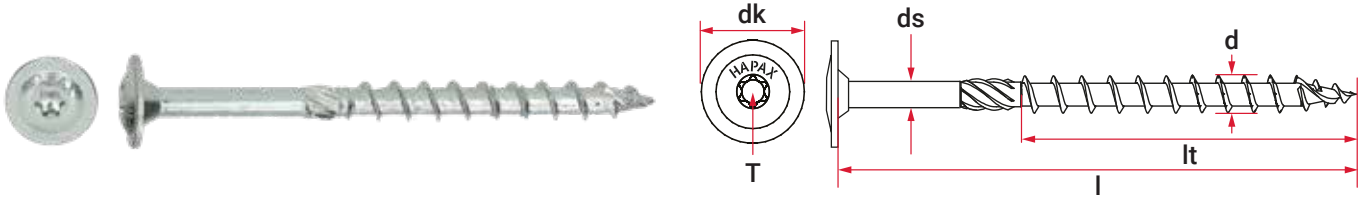

ETA 20/0787 - Screws for use in timber construction
DoPn° - 20-0787-01



Art. ref.	EAN code	d [mm]	l [mm]	lt [mm]	dk [mm]	Recess type	pcs / Box	pcs / Outer carton	pcs / Pallet
HAETTG001006000303	5410439471763	6	30		14	T 30	100	3600	86400
HAETTG001006000403	5410439471770	6	40	24	14	T 30	100	2400	57600
HAETTG001006000503	5410439471787	6	50	30	14	T 30	100	2400	57600
HAETTG001006000603	5410439471794	6	60	36	14	T 30	100	1600	38400
HAETTG001006000703	5410439471800	6	70	42	14	T 30	100	1600	38400
HAETTG001006000803	5410439471817	6	80	48	14	T 30	100	1600	38400
HAETTG001006001003	5410439471824	6	100	60	14	T 30	100	1600	38400
HAETTG001006001203	5410439471831	6	120	75	14	T 30	100	1200	28800
HAETTG001006001403	5410439471848	6	140	80	14	T 30	100	1200	28800
HAETTG001006001603	5410439471855	6	160	90	14	T 30	100	800	19200
HAETTG001006001803	5410439471862	6	180	100	14	T 30	100	800	19200
HAETTG001006002003	5410439471879	6	200	100	14	T 30	100	800	19200
HAETTG001006002203	5410439471886	6	220	100	14	T 30	100	800	19200
HAETTG001006002403	5410439471893	6	240	100	14	T 30	100	600	14400
HAETTG001006002603	5410439471909	6	260	100	14	T 30	100	600	14400
HAETTG001006002803	5410439471916	6	280	100	14	T 30	100	600	14400
HAETTG001006003003	5410439471923	6	300	100	14	T 30	100	600	14400
HAETTG001008000403	5410439471930	8	40	24	21	T 40	50	1800	43200
HAETTG001008000503	5410439471947	8	50	30	21	T 40	50	800	19200
HAETTG001008000603	5410439471954	8	60	36	21	T 40	50	800	19200
HAETTG001008000803	5410439471961	8	80	48	21	T 40	50	800	19200
HAETTG001008001003	5410439471978	8	100	60	21	T 40	50	600	14400
HAETTG001008001203	5410439299329	8	120	75	21	T 40	50	600	14400
HAETTG001008001403	5410439471985	8	140	80	21	T 40	50	600	14400
HAETTG001008001603	5410439471992	8	160	90	21	T 40	50	400	9600
HAETTG001008001803	5410439472005	8	180	100	21	T 40	50	400	9600
HAETTG001008002003	5410439472012	8	200	100	21	T 40	50	400	9600
HAETTG001008002203	5410439472029	8	220	100	21	T 40	50	400	9600

Art. ref.	EAN code	d [mm]	l [mm]	lt [mm]	dk [mm]	Recess type	pcs / Box	pcs / Outer carton	pcs / Pallet
HAETTG001008002403	5410439472036	8	240	100	21	T 40	50	300	7200
HAETTG001008002603	5410439472043	8	260	100	21	T 40	50	200	4800
HAETTG001008002803	5410439472050	8	280	100	21	T 40	50	200	4800
HAETTG001008003003	5410439472067	8	300	100	21	T 40	50	200	4800
HAETTG001008003203	5410439472074	8	320	100	21	T 40	50	200	4800
HAETTG001008003403	5410439472081	8	340	100	21	T 40	50		5400
HAETTG001008003603	5410439472098	8	360	100	21	T 40	50		5400
HAETTG001008003803	5410439472104	8	380	100	21	T 40	50		5400
HAETTG001008004003	5410439472111	8	400	100	21	T 40	50		5400
HAETTG001008004403	5410439472128	8	440	100	21	T 40	50		5100
HAETTG001008004503	5410439472135	8	450	100	21	T 40	50		5100
HAETTG001010000603	5410439472142	10	60	36	24,5	T 40	50	600	14400
HAETTG001010000803	5410439472159	10	80	48	24,5	T 40	50	600	14400
HAETTG001010001003	5410439472166	10	100	60	24,5	T 40	50	600	14400
HAETTG001010001203	5410439472173	10	120	75	24,5	T 40	50	400	9600
HAETTG001010001403	5410439472180	10	140	80	24,5	T 40	50	400	9600
HAETTG001010001603	5410439472197	10	160	90	24,5	T 40	50	300	7200
HAETTG001010001803	5410439472203	10	180	100	24,5	T 40	50	300	7200
HAETTG001010002003	5410439472210	10	200	100	24,5	T 40	50	300	7200
HAETTG001010002203	5410439472227	10	220	100	24,5	T 40	50	400	9600
HAETTG001010002403	5410439472234	10	240	100	24,5	T 40	50	300	7200
HAETTG001010002603	5410439472241	10	260	100	24,5	T 40	50		6150
HAETTG001010002803	5410439472258	10	280	100	24,5	T 40	50		6150
HAETTG001010003003	5410439472265	10	300	100	24,5	T 40	50		5400
HAETTG001010003203	5410439472272	10	320	100	24,5	T 40	50		5400
HAETTG001010003403	5410439472289	10	340	100	24,5	T 40	50		5400
HAETTG001010003603	5410439472296	10	360	100	24,5	T 40	50		5400
HAETTG001010003803	5410439472302	10	380	100	24,5	T 40	50		5100
HAETTG001010004003	5410439472319	10	400	100	24,5	T 40	50		5100
HAETTG001010004403	5410439472326	10	440	100	24,5	T 40	25		

Hapax façade screw: ideal for installing wooden façade cladding

Façade screw with excellent anti-corrosion properties

The Hapax façade screw in A4 stainless steel is suitable for applications in wooden façade cladding thanks to its excellent anti-corrosion properties.

The screw is equipped with the patented 'triple thread' tip and has a reduced head (60°) of just 5.2 mm. Pre-drilling is not necessary, depending on the type of wood used,

and the screw can be positioned close to the edge without splitting the wood. The screw is also used as a glazing bead screw.



HAFVTG

Façade screw with extra small head

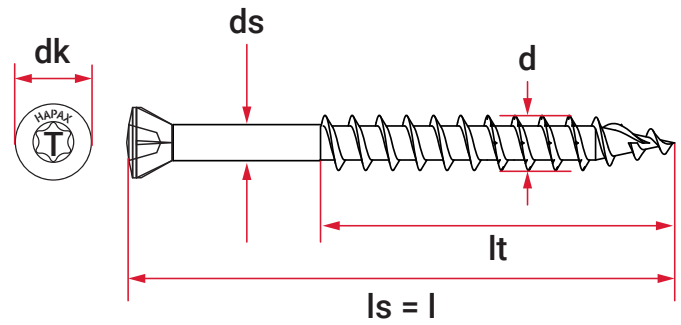

Art. ref.	EAN code	d [mm]	l [mm]	lt [mm]	dk [mm]	Recess type	pcs / Box	pcs / Outer carton
Big packaging								
HAFVTGB00003200352	5410439064415	3,2	35	21	5,2	T 10	1000	16000
HAFVTGB00003200402	5410439064422	3,2	40	24	5,2	T 10	1000	12000
HAFVTGB00003200502	5410439064439	3,2	50	30	5,2	T 10	1000	8000
HAFVTGB00003200602	5410439064538	3,2	60	36	5,2	T 10	1000	8000

Standard packaging

HAFVTGB00003200353	5410439091084	3,2	35	21	5,2	T 10	200	12000
HAFVTGB00003200403	5410439091091	3,2	40	24	5,2	T 10	200	9600
HAFVTGB00003200503	5410439091107	3,2	50	30	5,2	T 10	200	9600
HAFVTGB00003200603	5410439091145	3,2	60	36	5,2	T 10	200	9600

* Available on request : HAFVTG with black head - RAL 9005



Bit holders and bits: Ideal in combination with the Hapax screws

Maglock bit holder

Long screws are often used in wood constructions. These long screws can sometimes cause difficulties during installation.

With the Hapax Maglock Bit Holder you have a strong magnet that keeps the screw in place. In addition, a magnetic ring that you slide forward

secures the head of the screw. This way the screw sticks even better to the bit.

Easyclick bit holder

When screwing, the bit sometimes gets stuck in the screw. The Hapax Easyclick bit holder really clicks into place, making sure that the bit stays in the holder.

Taking the bit out of the bit holder can easily be done by pressing the button. After pressing the button, the bit will jump out of the bit holder, which makes changing the screwdriver bit much easier. In short, an everyday gamechanger.



EasyClick magnetic bit holder

HAP036



Art. ref.	EAN code	l [mm]	Socket drive	pcs / Box
HAP036MBH011	5410439091237	66	1/4"	1

MagLock magnetic bit holder

HAP036



Art. ref.	EAN code	l [mm]	Socket drive	pcs / Box
HAP036MBH021	5410439091244	64	1/4"	1

Hapax impact bits

HAP037



Art. ref.	EAN code	Recess	l [mm]	Socket drive	pcs / Box
HAP037B025IT101	5410439103879	Tx 10	25	1/4"	2
HAP037B025IT151	5410439103923	Tx 15	25	1/4"	2
HAP037B025IT201	5410439103954	Tx 20	25	1/4"	2
HAP037B025IT251	5410439103961	Tx 25	25	1/4"	2
HAP037B025IT301	5410439103992	Tx 30	25	1/4"	2
HAP037B025IT401	5410439104005	Tx 40	25	1/4"	2



***DESIGNED
FOR LIFE.***





Quality by **pgb** — europe



Discover Hapax Fixing Pro, the high-quality hidden fastening system for wooden decks. This patented system is the reference for deck fixings and is recommended by renowned professionals in the industry.

“The invisibility of the screws give an aesthetic touch to your deck.”

Hapax Fixing Pro: The hidden fastening system



The Hapax Fixing Pro fixing system

This system has a number of advantages. First of all, the system is completely hidden which gives the deck a more aesthetic finish. In addition, the system is also easy to install.

The thickness of the components, which is 13 mm, allows for excellent ventilation between the boards and the supporting structure of the decking. This significantly extends the life span of the deck.

Suitable for various board widths

Fixing pro is designed to be used with different board widths. Standard board widths are 140-145mm. But the system is designed to use boards with a width of 90 to 200 mm, who can have a thickness from 20 to 40 mm.

By using the system you also ensure better stability of the wooden deck. The components ensure that water has no chance to accumulate. This prevents the deck from rotting or deforming.

The 7 advantages of the Hapax Fixing Pro system

- Hidden : you don't see the screws or components.
- An aesthetic and professional finished result.
- Excellent ventilation between the substructure and the boards.
- Easy to install thanks to the included stainless steel screws.
- The possibility to replace a broken board without disassembling everything.
- UV-resistant and resistant to temperature fluctuations.
- 100% recyclable.

Hapax Fixing Pro: the invisible fixing system

Wood types

Can be used with the following hardwood: Ipe, Padauk, Bamboo, Ash, Poplar, Oak, Accoya, Afzelia, Merbau, Moabi, Sapelli, Sipo, Teak, Canadian Western Red Cedar.

Can also be used in the following Kiln dried woods: Cumaru, Tali, Afrormosia, Bankirai, Iroko and Tatajuba.

Stainless steel C2 AISI 410

Stainless steel screws type C2 are the least corrosion resistant of all types of stainless steel screws. On the other hand, these screws have the best mechanical properties.

You use these terrace screws if there are no other factors that can affect the screws.

Stainless steel A4 AISI 316

Where there are extra factors that can cause accelerated oxidation, you should choose stainless steel A4 screws. These are mainly environments where chemical factors play a role, such as around swimming pools, but also in coastal areas, where salty sea air can oxidate the steel. Certain acids in hardwood can also cause accelerated oxidation.

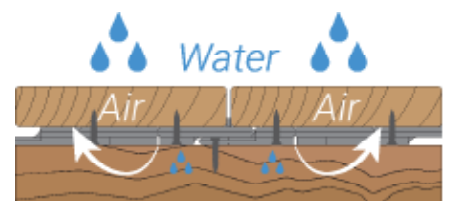

	Art. ref.	EAN code	Thickness of the board	pcs / Box	pcs / Pal.
C2 Ipe	HAP010C00FIXPRO3	5410439473682	Hapax FIXING PRO can be used for boards from 90 to 200 mm wide and 19 to 40 mm thick.	100 x Fixing 200 x 5,5 x 30mm 100 x 5,5 x 35mm	88
A4 Ipe	HAP010B00FIXPRO3	5410439475983		100 x Fixing 200 x 5,5 x 30mm 100 x 5,5 x 35mm	88
C2 Ipe	HAP011C00FIXPRO3	5410439473699		100 x Fixing 300 x 5,5 x 35mm	88

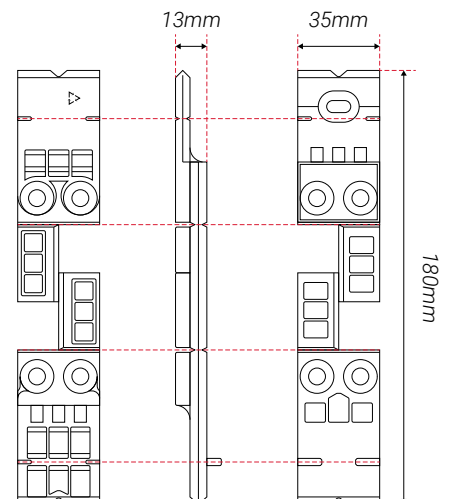

*C2 = non-aggressive environments
Outdoor applications ≥ 10 km from the coast, not in the vicinity of e.g. swimming pools.

*A4 = suitable for outdoor applications at the coast and in the vicinity of swimming pools.



“Fixing Pro offers the possibility to replace a damaged board when necessary.”



Get to know Hapax D-Pro, a quality system for installing wooden decking. The system uses a clip that provides ventilation between the deck boards and the substructure. Ideal for use when the deck is visibly screwed down.

“Thanks to D-Pro, the decking can breathe sufficiently and therefore prevents rotting of the wood.”

Hapax D-Pro: The ventilation pad for a durable terrace



The Hapax D-Pro Fixing System

Like any fixing system, the Hapax D-Pro system has some distinct advantages.

First of all, there is the ventilating characteristic of the D-Pro clip. By using the clip you prevent the decking boards from coming into contact with the underlying beam structure. This ensures that there is always sufficient ventilation, which significantly reduces the risk of the decking boards bending.

In addition, the ventilating characteristic ensures that there is no chance of water accumulating between the board and the underlying substructure. Therefore rotting of the deck is prevented. This considerably extends the life span of the decking.

Some of the D-Pro clips are also equipped with a spacer. This ensures that you always maintain the chosen joint width when installing the deck. Which results in a nicely finished deck. There is a choice of 4, 5, 6 and 7mm in width.

The advantages of Hapax D-Pro

- Excellent ventilation between the boards and the substructure.
- Reduces the risk of bending the boards.
- The D-Pro clip prevents rotting of the wood.
- Integrated spacers.
- Shock absorbing effect of the D-Pro clip softens the walking noise.

Hapax D-Pro: improved stability for your terrace

Properties

- Prevents thermal bridges
- Shock absorbing
- Removable spacers
- Frost resistant up to -40°C
- Heat resistant up to 110°C
- recycled composite

Stainless steel A2 AISI 304

Stainless steel A2 is the most common type of stainless steel used in fasteners. Stainless steel A2 screws combine excellent corrosion resistance with good mechanical properties. They have good resistance to acids in tropical and European hardwoods. You can use them in environments with high humidity or exposed to moisture, but they are not chemically resistant.

Stainless steel A4 AISI 316

When additional factors appear that can cause accelerated oxidation, you should choose stainless steel A4 screws. This mainly concerns environments where chemical factors come into play, such as swimming pool areas, but also in coastal regions, where salty sea air can affect the steel. Furthermore, certain acids in hardwood can also cause accelerated oxidation.

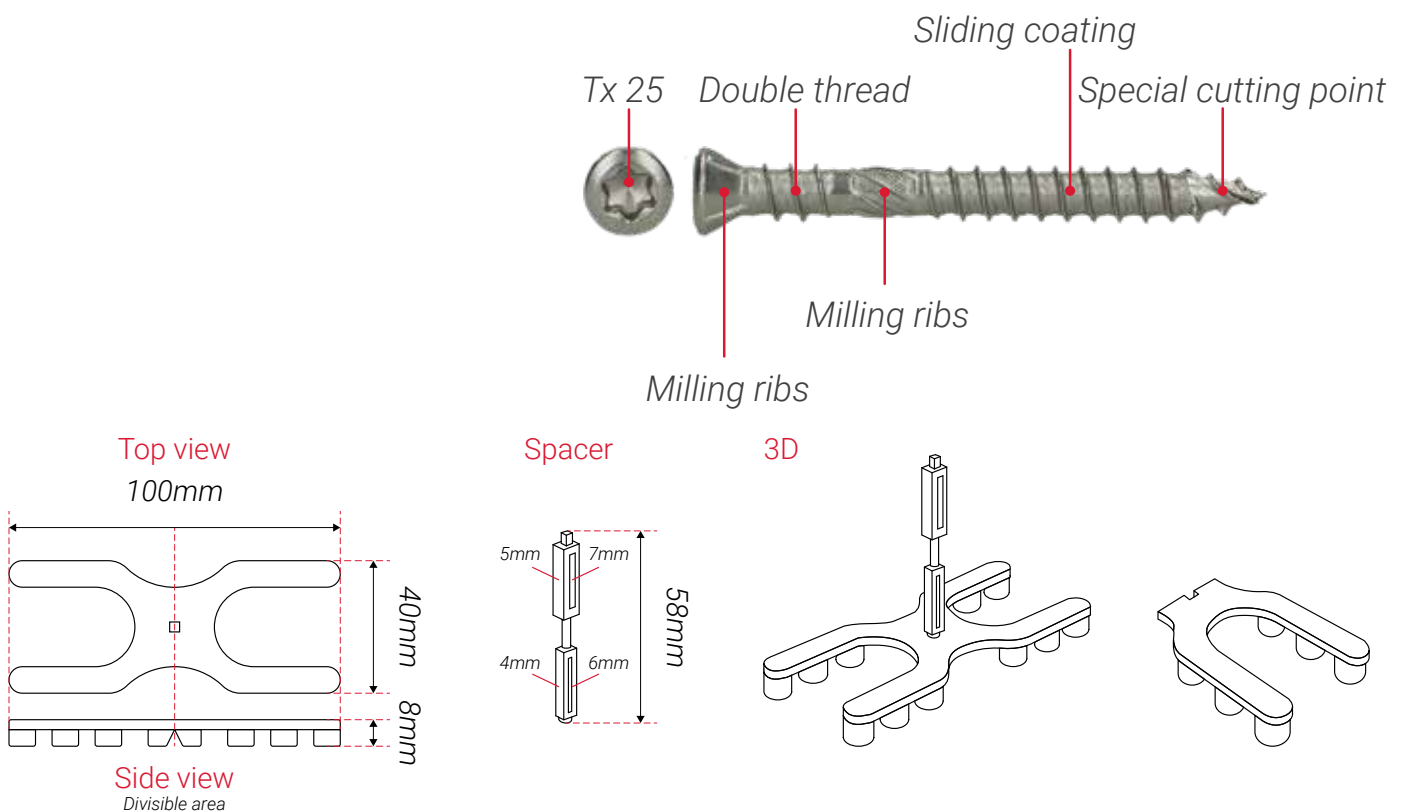



Art. ref.	EAN code	d [mm]	l [mm]	D-Pro [mm]	pcs / Box	pcs / Pal.
HAP020A00DPRO3	5410439473736	5	60	8 x 100 x 40	100 x D-Pro 20 x 4 x 5 x 6 x 7 mm 200 x 5 x 60mm	192
HAP021A00DPRO3	5410439473743	5	70	8 x 100 x 40	100 x D-Pro 20 x 4 x 5 x 6 x 7 mm 200 x 5 x 60mm	192



Art. ref.	EAN code	d [mm]	l [mm]	D-Pro [mm]	pcs / Box	pcs / Pal.
HAP020B00DPRO3	5410439479271	5	60	8 x 100 x 40	100 x D-Pro 20 x 4 x 5 x 6 x 7 mm 200 x 5 x 70mm	192
HAP021B00DPRO3	5410439479288	5	70	8 x 100 x 40	100 x D-Pro 20 x 4 x 5 x 6 x 7 mm 200 x 5 x 70mm	192

“By providing ventilation between the board and the substructure, the risk of bending is greatly reduced.”



Deck D - Hardwood screws

In bucket



Art. ref.	EAN code	d [mm]	l [mm]	Screws per bucket	pcs / Pal.
HAP020A000050050M	5410439479134	5	50	650	84
HAP020A000050060M	5410439479141	5	60	650	84
HAP020A000050070M	5410439479158	5	70	550	84

Deck D - Hardwood screws in set

In bucket

*(Incl. 1 countersink drill 90° - ø 4mm | 3 x Spacers - 4/5/6/7mm | Elite bits - 25mm x T25 - 1/4" - C6.3 Stainless steel)



Art. ref.	EAN code	d [mm]	l [mm]	Screws per bucket	pcs / Pal.
HAP020A00SET050M	5410439478069	5	50	650	84
HAP020A00SET060M	5410439478076	5	60	650	84
HAP020A00SET070M	5410439478083	5	70	550	84

D-Pro - without Hardwood screws

Plastic bag packaging



Art. ref.	EAN code	D-Pro [mm]	pcs / bag
HAP020N00DPRO15	5410439104326	8 x 100 x 40	100 x D-Pro 20 x 4 x 5 x 6 x 7 mm

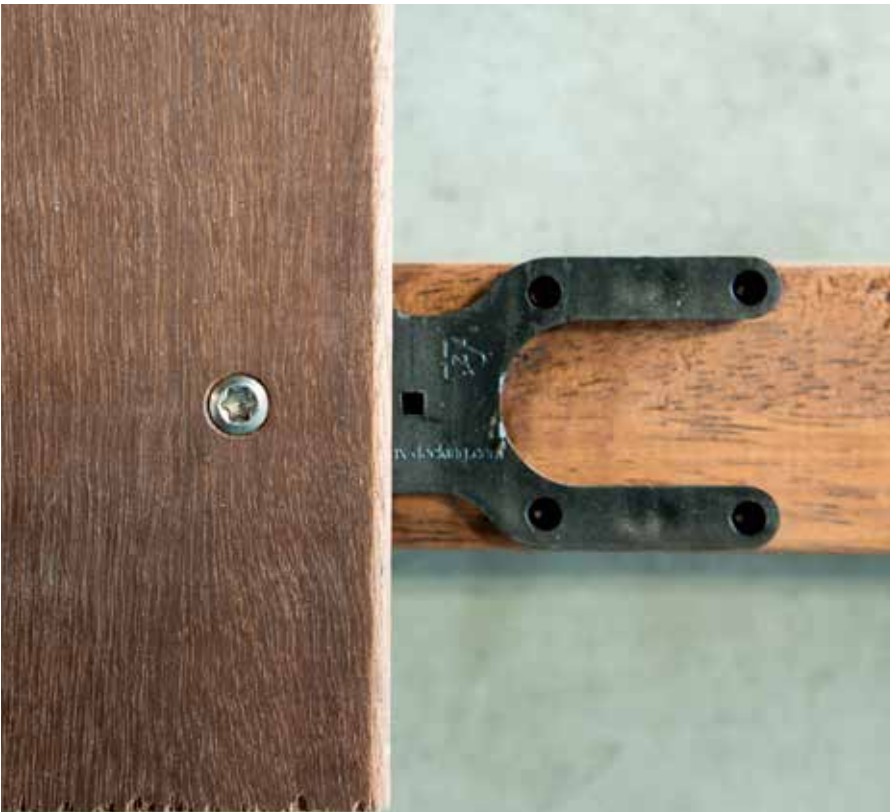



Together we go for quality. Discover the Hapax Atlas, an adjustable terrace support that is suitable for wooden terraces as well as for concrete, ceramic and natural stone tiles.

“You can manually adjust the decking supports to the desired height.”

Hapax Atlas: The adjustable decking support



The Hapax Atlas adjustable decking supports

The decking supports are made of plastic and are adjustable. You can choose between a support plate for building a wooden deck and a support plate for laying tiles.

The decking supports can easily be set to the desired height by hand. If the obtained height is insufficient, you can always use an extension piece. Each time you use an extension piece you gain 35mm in height.

Because of the space that is created under the terrace, they ensure a smooth drainage of water. In addition, the joints between the floor elements can be left open so that the water can seep through.

The 7 advantages of the Hapax Atlas decking supports :

- Suitable for wood and tiles.
- The space underneath the terrace ensures a smooth water drainage.
- Joints are left open, reducing the risk of cracking.
- UV-resistant and resistant to extreme temperatures.
- 100% recyclable.
- Easy and quick to install.
- Extends the life of the deck.

Hapax ATLAS - Adjustable decking supports

For use with wooden substructure



* 50-90mm excl. support plate - extendable



Art. ref.	EAN code	h min [mm]	h max [mm]	pcs / Bag	pcs / Pal.
HAP042ATLAS03051	5410439606523	30	50	50	1000
HAP042ATLAS05091		50	90	50	700

Hapax ATLAS - Adjustable decking supports

For use with tiles



* 50-90mm excl. support plate - extendable



Art. ref.	EAN code	h min [mm]	h max [mm]	pcs / Bag	pcs / Pal.
HAP042ATLAS0305T1	5410439013307	30	50	50	1000
HAP042ATLAS05091	5410439606561	50	90	50	700

Support plate for wood

HAP042ATLASPLW1



EAN code	d [mm]	pcs / Bag	pcs / Pal.
5410439606608	122	250 (5x50)	4000

Support plate for tiles

HAP042ATLASPLT1



EAN code	d [mm]	pcs / Bag	pcs / Pal.
5410439607063	122	250 (5x50)	4000



Extension

HAP042ATLASEXT1



*Only to be used with a
50-90mm decking bracket

EAN code	h [mm]	pcs / Bag	pcs / Pal.
5410439607025	35	250 (5x50)	4000

Extension

HAP042ATLASEXT1001



*Supplied with screw thread and increases
the reach of a deck support per 100mm,
maximum stacking of 9pcs.

EAN code	d [mm]	pcs / Bag	pcs / Pal.
5410439115537	80	100	2400

Slope corrector 2%

HAP042ATLASSC21



EAN code	d [mm]	pcs / Bag	pcs / Pal.
5410439115551	220	100	2000





Get to know Hapax Rock. The ecological screw foundation is suitable for installing wooden structures. Thanks to Hapax Rock, it is no longer necessary to lay a concrete foundation. After placing the Hapax Rock, you can immediately start constructing the deck.

“Easy to install, remove and recycle, thus reducing the impact on the ecosystem.”

Hapax Rock: ecological & simple

The advantages of the Hapax Rock screw foundation

The Hapax Rock screw foundation is easy to install. This can be done using a manual or electric ‘screw-in’ tool. It only takes 5 minutes. In addition, the screw foundation has a nut for quick and easy levelling of the screw foundation.

Furthermore, the Hapax Rock can easily be removed and recycled, in contrast to, for example, a traditional concrete foundation. This limits the impact on the ecosystem.

Calculation for use with a double substructure

The required number of Hapax Rock elements can be easily calculated using the formula below :
number of m² terrace x 0,6.

Characteristics of the Hapax Rock

- Adjustable between 35 - 250mm
- head diameter: 123mm for 120 x 200mm boards
- Material: polypropylene
- Frost resistance: -50°C
- Heat resistant: 90°C
- Load capacity per element: 800 kg



Hapax Rock Screw foundation

Properties

- Replaces concrete foundations
- Adjustable between 35 - 250mm
- Frost resistance up to -50°C
- Heat resistant up to 90°C
- Load capacity: 800 kg
- Recycled plastic
- Tested by the WTCB

Beam support

Adjustable screw head

Safety nut

Screw foundation



Hapax Rock

Art. ref.	EAN code	d [mm]	l [mm]	pcs / Pal.
HAP040N00ROCK1	5410439473842	Ø140	700	50

FRONT VIEW

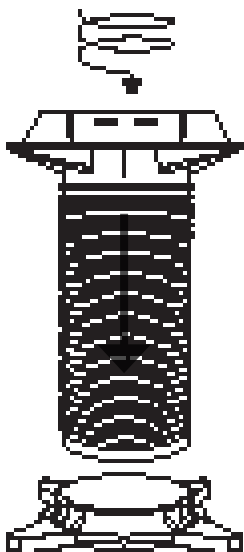

SIDE VIEW

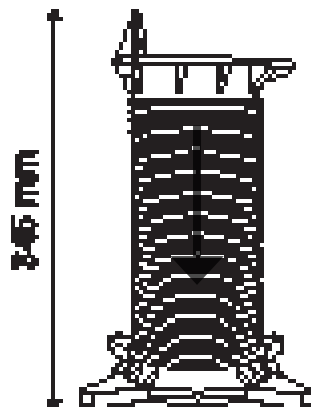

TOP VIEW

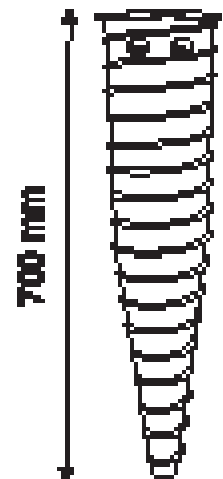
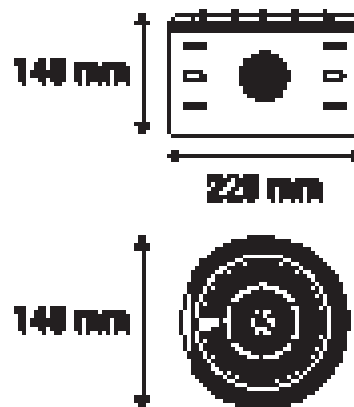

Rock Extension - 160 mm

With the Hapax Rock extension piece, you can bridge a height of 160 mm at a time.
The maximum number of stacked Rock extension pieces is 5.

Art. ref.	EAN code	d [mm]	l [mm]	pcs / Pal.
HAP040N00ROCKEXT1	5410439473835	Ø140	260	252



E-driver for Rock foundation

HAP041N00EDRIVER1



EAN code	Nm	pcs / Box	pcs / Pal.
5410439473828	2000	1	1

Hapax screw aid Rock

HAP041N00TDRIVER1



EAN code	pcs / Box	pcs / Pal.
5410439473811	1	1



**“Hapax Rock
replaces the
traditional concrete
foundation”**

Hapax Tool: Tool for the installation of decking boards

“With this tensioner, you can effortlessly straighten and tighten the boards of your deck during assembly.”

First aid for warped boards

Are your boards slightly warped? Then it is best to use an auxiliary tool to clamp the boards in the correct place. For this you can use our Hapax Tool.

Optimal force transfer

The Hapax Tool can be used to clamp boards. When you apply a force of 20kg to the handle, this results in a force of 85kg.

Tool

HAP030

Art. ref.	EAN code	d [mm]	l [mm]	w [mm]	pcs / Box
HAP030CLAMP1	5410439473750	20	40	40	1

Pin

HAP030

Art. ref.	EAN code	d [mm]	l [mm]	pcs / Box
HAP030PINOCLAMP1	5410439473767	M10	70	1

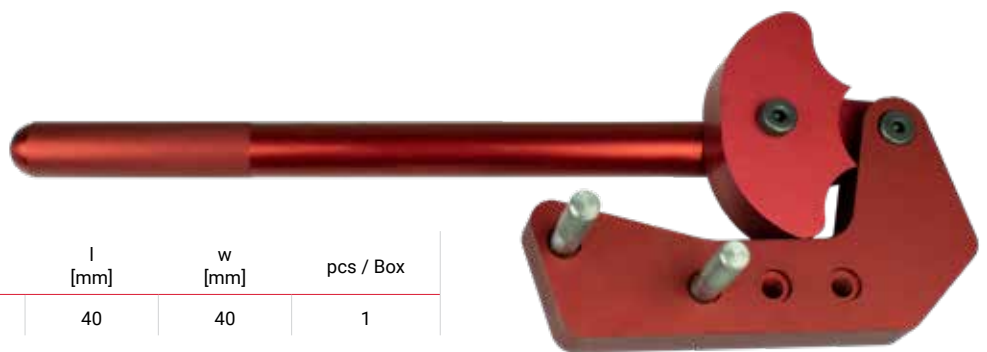



G-deck: accessory for installing deck screws

“G-deck ensures easy installation and precise alignment of the screws.”

Accurate work with the G-deck

If you opt for a fixing system in which the screws remain visible, you should use the G-deck attachment.

The G-deck attachment ensures that you always maintain the same pre-drilling depth and that you always mount the screws in line.

Adjustable from 90 to 200mm

The attachment is suitable for boards of different widths. This can range from 90 to 200 mm.

In addition, the countersink drill bit (Ø 4mm) that is included ensures that the wood is provided with a countersink space in which the head of the screw fits neatly.

Mounting template G-Deck

HAP030

*(1 Dowel drill bit with countersink 90° - Ø 4mm inclusive)

Art. ref.	EAN code	d [mm]	l [mm]	w [mm]	pcs / Box
HAP030GDECK1	5410439473774	6	200	80	1



Drill with stop function

HAP031

*(Hexagon L-key inclusive)

Art. ref.	EAN code	d	pcs / Box
HAP031DRILL0401	5410439473781	Ø4	1
HAP031DRILL0501	5410439473798	Ø5	1
HAP031DRILL0601	5410439473804	Ø6	1





Spare drill for drill with stop function

HAP031

Art. ref.	EAN code	d	pcs / Box
HAP031SPARE0401	5410439004558	Ø4	1
HAP031SPARE0501	5410439004565	Ø5	1
HAP031SPARE0601	5410439104944	Ø6	1



Dowel drill bit with countersink 90°

HAP035

Art. ref.	EAN code	d	pcs / Box
HAP035DRILL0401	5410439476140	Ø4	1
HAP035DRILL0501	5410439476157	Ø5	1
HAP035DRILL0601	5410439476164	Ø6	1



Insulation pad in EPDM: Increases stability and protects the substructure

EPDM insulation pad

HAP033



Durability and comfort

The insulation pads in recycled EPDM, a durable material that's weatherproof and does not rot, are suitable for use on a flat surface. They eliminate small differences in the surface and contribute to maintaining the stability and durability of the substructure. In addition, they help to reduce creaking noises and increase walking comfort.

Art. ref.	EAN code	d [mm]	l [mm]	w [mm]	pcs / Box	pcs / Outer carton
HAP033PAD015	5410439081962	1	100	100	190	1140
HAP033PAD025	5410439082006	2	100	100	90	540
HAP033PAD035	5410439082082	3	100	100	60	360
HAP033PAD055	5410439082129	5	100	100	36	216
HAP032PAD5	5410439482424	8	100	100	24	144
HAP033PAD105	5410439082181	10	100	100	18	108

The Hapax spacer: ideal for maintaining the selected joint width

Different joint widths in 1 handy tool

With the handy Hapax spacer you can efficiently maintain the selected joint width between your deck boards. The Hapax spacer allows you to choose a joint width that ranges from a minimum of 4mm to a maximum of 7mm. Each blister pack contains 3 spacers.

HAP034N000001A

4 joint widths

EAN code	d [mm]	pcs / Bag	Bags / Outer car.
5410439476768	4-5-6-7	3	40



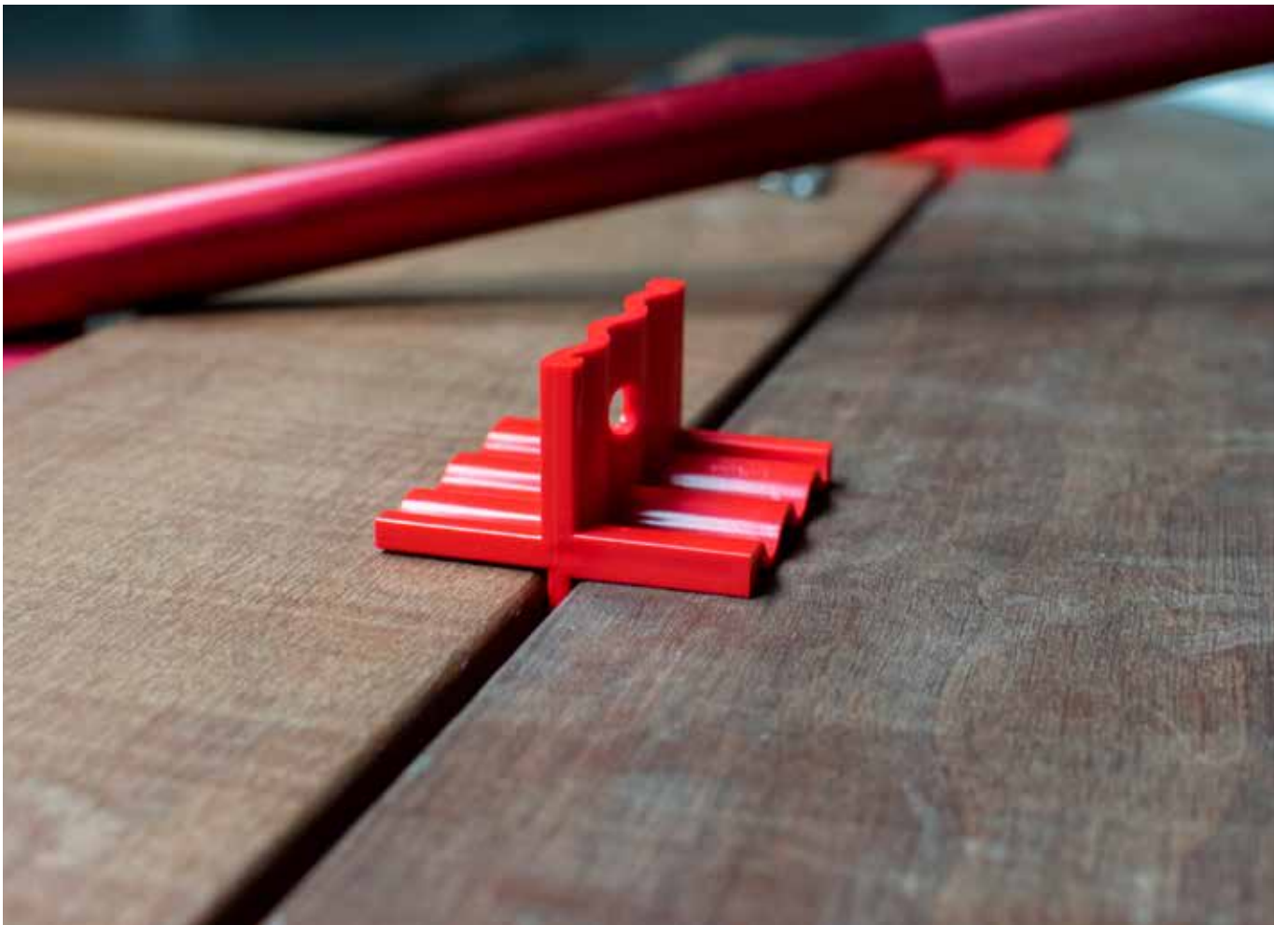

Flat wedges: For filling out and levelling

Levelling

Wedges can be used in numerous applications. One of the applications, for example, is the installation of a framework. Here, the wedges are placed around the frame and prevent the frame from coming into contact with the surface. Furthermore, wedges are also used for leveling wooden façades and battens, for laying parquet, etc.



Packer shims

HAP050

Ideal for quick filling and levelling of small heights



Art. ref.	EAN code	d [mm]	w [mm]	l [mm]	Max. weight	pcs / Box	pcs / Pal.
HAP050N00001000955	5410439473859	1	22	95	300 kg	100	72
HAP050N00002000955	5410439473866	2	22	95	300 kg	100	72
HAP050N00003000955	5410439473873	3	22	95	300 kg	100	72
HAP050N00004000955	5410439473880	4	22	95	300 kg	100	72
HAP050N00005000955	5410439473897	5	22	95	300 kg	100	72

Packer shims - Mix

HAP051

Ideal for quick filling and levelling of small heights



Art. ref.	EAN code	d [mm]	w [mm]	l [mm]	Max. weight	pcs / Box	pcs / Pal.
HAP051N00SET01M	5410439473903	1-5	22	95	300 kg	40 x 1mm 40 x 2mm 40 x 3mm 40 x 4mm 40 x 5mm	189
HAP051N00SET02M	5410439473910	1-5	22	95	300 kg	100 x 1mm 100 x 2mm 100 x 3mm 100 x 4mm 100 x 5mm	112

Filler plates: Indispensable on every construction site

Colourful & efficient

For easy levelling of cladding, uprights and door or window frames. With a handy comb function for extra grip around the screw when needed.

The efficient colour-coding enables the correct width to be identified at a glance.



Hanger shims

HAP052

Ideal for filling and levelling wooden structures



Art. ref.	EAN code	d [mm]	w [mm]	l [mm]	pcs / Box	pcs / Pal.
HAP052N00001000555	5410439473927	1	40	55	1000	72
HAP052N00002000555	5410439473934	2	40	55	1000	72
HAP052N00003000555	5410439473941	3	40	55	1000	48
HAP052N00004000555	5410439473958	4	40	55	1000	48
HAP052N00005000555	5410439473965	5	40	55	1000	40

Hanger shims - Mix

HAP052

Ideal for filling and levelling wooden structures



Art. ref.	EAN code	d [mm]	w [mm]	l [mm]	pcs / Box	pcs / Pal.
HAP052N00SET01M	5410439473972	1-5	40	55	40 x 1mm 40 x 2mm 40 x 3mm 40 x 4mm 40 x 5mm	189
HAP052N00SET02M	5410439473989	1-5	40	55	100 x 1mm 100 x 2mm 100 x 3mm 100 x 4mm 100 x 5mm	50

Adjustable wedges: Quick and easy to use

Stable & permanent

Handy for immediate use when levelling and aligning various building components. Quick and easy to use without preparation.

Can be nailed through for final installation, for a stable and permanent installation.



Interlocking wedges

HAP053

Ideal for laying wooden floors

Art. ref.	EAN code	h [mm]	w [mm]	l [mm]	Max. weight	pcs / Box	pcs / Pal.
HAP053N00030000905	5410439476225	14	30	90	300 kg	200	72
HAP053N00043000955	5410439476232	15	43	95	300 kg	200	48
HAP053N00043001505	5410439476249	22	43	150	300 kg	100	48



Interlocking wedges - Mix

HAP053

Ideal for laying wooden floors

Art. ref.	EAN code	h [mm]	w [mm]	l [mm]	Max. weight	pcs / Box	pcs / Pal.
HAP053N00SET01M	5410439473996	14-22	30-43	90-150	300 kg	50 pcs : 14 x 30 x 90mm 30 pcs : 15 x 43 x 95mm 10 pcs : 22 x 43 x 150mm	112
HAP053N00SET02M	5410439474009	14-22	30-43	90-150	300 kg	90 pcs : 14 x 30 x 90mm 60 pcs : 15 x 43 x 95mm 50 pcs : 22 x 43 x 150mm	50



Heavy duty wedges: Ideal for levelling timber structures

For levelling timber structures

The Heavy Duty wedges are made of high quality PE (Polyethylene) and are therefore very durable and strong, without being subject to deformation. These wedges have a number of pins that ensure a stable stacking of the wedges. If you do not wish to use them, they can easily be removed with a cutter knife.



High density packers

HAP054

Ideal for filling and levelling heavy loads

Art. ref.	EAN code	d [mm]	w [mm]	l [mm]	Max. weight	pcs / Box	pcs / Pal.
HAP054N00002001005	5410439474016	2	50	100	2000 kg	500	72
HAP054N00003001005	5410439474023	3	50	100	2000 kg	500	72
HAP054N00004000505	5410439474047	5	50	100	2000 kg	500	48
HAP054N00010001005	5410439474054	10	50	100	2000 kg	250	48



High density packers - Mix

HAP054

Ideal for filling and levelling heavy loads

Art. ref.	EAN code	d [mm]	w [mm]	l [mm]	Max. weight	pcs / Box	pcs / Pal.
HAP054N00SET01M	5410439474061	2-10	50	100	2000 kg	100 pcs : 2 x 50 x 100mm 40 pcs : 3 x 50 x 100mm 40 pcs : 5 x 50 x 100mm 20 pcs : 10 x 50 x 100mm	112



pgb HOUTSCHROEVEN

www.pgbbestellen.nl
INNOVATIEVE HOUTSCHROEVEN
INNOVATIEVE HOUTSCHROEVEN
pgb

FHAPAX

FHAPAX



NIEUW!
INNOVATIEVE HOUTSCHROEVEN



TERRAS
UNIVERSEEL
CONSTRUCTIE

pgb

3 x 16
3 x 20
3 x 25
3 x 30
3 x 35
3 x 40
3 x 45
3 x 50
3 x 55
3 x 60
3 x 65
3 x 70
3 x 75
3 x 80
3 x 85
3 x 90
3 x 95
3 x 100

3 x 40
3 x 45
3 x 50
3 x 55
3 x 60
3 x 65
3 x 70
3 x 75
3 x 80
3 x 85
3 x 90
3 x 95
3 x 100

3 x 40
3 x 45
3 x 50
3 x 55
3 x 60
3 x 65
3 x 70
3 x 75
3 x 80
3 x 85
3 x 90
3 x 95
3 x 100

3 x 40
3 x 45
3 x 50
3 x 55
3 x 60
3 x 65
3 x 70
3 x 75
3 x 80
3 x 85
3 x 90
3 x 95
3 x 100

3 x 100
3 x 110
3 x 120
3 x 130
3 x 140
3 x 150
3 x 160
3 x 170
3 x 180
3 x 190
3 x 200
3 x 210
3 x 220
3 x 230
3 x 240
3 x 250
3 x 260
3 x 270
3 x 280
3 x 290
3 x 300
3 x 310
3 x 320
3 x 330
3 x 340
3 x 350
3 x 360
3 x 370
3 x 380
3 x 390
3 x 400
3 x 410
3 x 420
3 x 430
3 x 440
3 x 450
3 x 460
3 x 470
3 x 480
3 x 490
3 x 500

At pgb-Europe, you're at the right place for all your retail questions!
As your experienced partner, we offer you personalised advice for
the correct and stylish fitting of your shop shelves.

“You benefit from optimised stock management and our unique logistical commitment.”

Get the most out of your retail space

Make optimal use of your available retail space by implementing the handy Hapax packaging in your shop shelves.

Our experienced representatives are always at your service to dress up your shop with our high-quality packaging and POS material.

1. Visibility

By implementing Hapax packaging, you opt for the best presentation possible. The product is always clearly visible and the necessary information is displayed clearly on the label using simple colour codes and symbols.

2. Merchandising service

In consultation with the customer, our experienced representatives develop a customised shelf plan. They take into account your personal wishes and inform you about the best-selling articles. Agreements are also made concerning the merchandising service, such as the provision of various types of POS material and banners.

3. Large stock

As a logistics partner, you can always rely on our knowledge and experience in the field of stock management. The pgb-Europe scanning app allows you to quickly and effortlessly keep the stock in your shop on point.

4. Deliveries

Depending on the agreements made, deliveries can be made at agreed times or on demand.

Tailor-made retail solutions!



UNIVERSAL SCREWS IN BLISTER

The universal wood screw with full thread and countersunk head

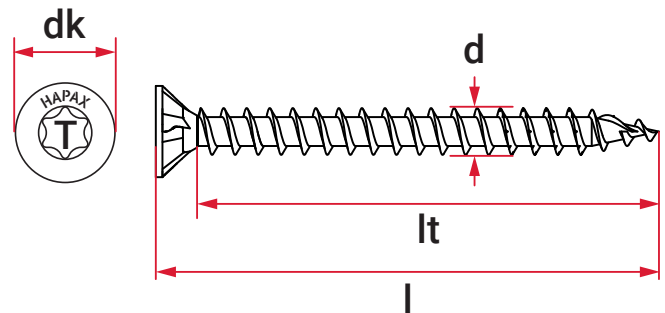

ETA 20/0787 - Screws for use in timber construction
DoPn° - 20-0787-01



Art. ref.	EAN code	d [mm]	l [mm]	lt [mm]	dk [mm]	Recess type	pcs / Blist.	blist. / Box min. sales quantity	blist. / Outer carton	st. / Pallet
HZ2VTV035016	5410439066129	3,5	16	12	7	T 15	100	6	72	3168
HZ2VTV035020	5410439076500	3,5	20	16	7	T 15	100	6	72	3168
HZ2VTV035030	5410439076494	3,5	30	25	7	T 15	100	6	72	3168
HZ2VTV035040	5410439077156	3,5	40	35	7	T 15	50	6	72	3168
HZ2VTV035050	5410439077163	3,5	50	45	7	T 15	50	6	72	3168
HZ2VTV040016	5410439078924	4	16	12	8	T 20	50	6	72	3168
HZ2VTV040020	5410439076487	4	20	16	8	T 20	50	6	72	3168
HZ2VTV040025	5410439076470	4	25	21	8	T 20	50	6	72	3168
HZ2VTV040030	5410439076463	4	30	25	8	T 20	50	6	72	3168
HZ2VTV040035	5410439076456	4	35	30	8	T 20	50	6	50	1500
HZ2VTV045030	5410439076449	4,5	30	25	8,8	T 20	50	6	50	1500
HZ2VTV045035	5410439076432	4,5	35	30	8,8	T 20	50	6	50	1500
HZ2VTV050020	5410439078993	5	20	16	9,7	T 25	40	6	50	1500
HZ2VTV050025	5410439076425	5	25	21	9,7	T 25	40	6	32	960
HZ2VTV050030	5410439076418	5	30	25	9,7	T 25	40	6	32	960
HZ2VTV050035	5410439076401	5	35	30	9,7	T 25	40	6	32	960
HZ2VTV060040	5410439076395	6	40	34	11,6	T 30	20	6	32	960
HZ2VTV060045	5410439076388	6	45	39	11,6	T 30	20	6	72	3168
HZ1VTV060050	5410439078665	6	50	43	11,6	T 30	10	6	25	750
HZ2VTV060050	5410439076371	6	50	43	11,6	T 30	20	6	25	750
HZ2VTV060060	5410439079075	6	60	53	11,6	T 30	20	6	25	750

UNIVERSAL SCREWS IN BLISTER

The universal wood screw with partial thread and countersunk head

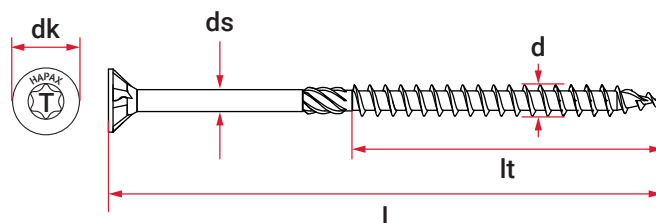

ETA 20/0787 - Screws for use in timber construction
DoPn° - 20-0787-01



Art. ref.	EAN code	d [mm]	l [mm]	lt [mm]	dk [mm]	Recess type	pcs / Blist.	blist. / Box min. sales quantity	blist. / Outer carton	st. / Pallet
HZ2VTG035040	5410439076791	3,5	40	23	7	T 15	50	6	25	750
HZ2VTG035050	5410439076784	3,5	50	32	7	T 15	50	6	25	750
HZ1VTG040040	5410439080859	4	40	23	8	T 20	25	6	16	480
HZ2VTG040040	5410439076777	4	40	23	8	T 20	50	6	16	480
HZ2VTG040045	5410439076760	4	45	30	8	T 20	50	6	16	480
HZ2VTG040050	5410439076753	4	50	32,5	8	T 20	50	6	16	480
HZ2VTG040060	5410439076746	4	60	35	8	T 20	50	6	72	3168
HZ2VTG040070	5410439077118	4	70	37,5	8	T 20	40	6	72	3168
HZ2VTG045040	5410439076739	4,5	40	25	8,8	T 20	50	6	72	3168
HZ2VTG045045	5410439078795	4,5	45	30	8,8	T 20	40	6	72	3168
HZ2VTG045050	5410439076722	4,5	50	32,5	8,8	T 20	40	6	72	3168
HZ2VTG045060	5410439076715	4,5	60	37	8,8	T 20	40	6	72	3168
HZ2VTG045070	5410439076708	4,5	70	42	8,8	T 20	40	3	72	3168
HZ2VTG045080	5410439076692	4,5	80	47	8,8	T 20	40	3	72	3168
HZ2VTG050040	5410439076685	5	40	27	9,7	T 25	40	6	72	3168
HZ2VTG050045	5410439076678	5	45	30	9,7	T 25	40	6	72	3168
HZ1VTG050050	5410439078610	5	50	32	9,7	T 25	15	6	72	3168
HZ2VTG050050	5410439076661	5	50	32	9,7	T 25	30	6	50	1500
HZ1VTG050060	5410439078634	5	60	37	9,7	T 25	15	6	50	1500
HZ2VTG050060	5410439076654	5	60	37	9,7	T 25	30	6	72	3168
HZ2VTG050070	5410439076647	5	70	41	9,7	T 25	30	3	72	3168
HZ2VTG050080	5410439066150	5	80	46	9,7	T 25	30	3	72	3168
HZ2VTG050090	5410439076630	5	90	61	9,7	T 25	30	3	72	3168
HZ2VTG050100	5410439076623	5	100	61	9,7	T 25	30	3	50	1500
HZ2VTG050120	5410439076616	5	120	69	9,7	T 25	30	3	50	1500
HZ1VTG060060	5410439078658	6	60	37	11,6	T 30	10	6	50	1500
HZ2VTG060060	5410439076609	6	60	37	11,6	T 30	20	3	50	1500
HZ2VTG060070	5410439076593	6	70	41	11,6	T 30	20	3	50	1500

UNIVERSAL SCREWS IN BLISTER

The universal wood screw with partial thread and countersunk head

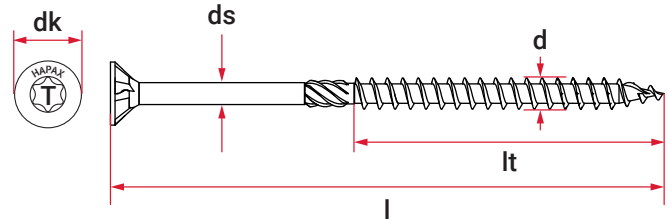

ETA 20/0787 - Screws for use in timber construction
DoPn° - 20-0787-01



Art. ref.	EAN code	d [mm]	l [mm]	lt [mm]	dk [mm]	Recess type	pcs / Blist.	blist. / Box min. sales quantity	blist. / Outer carton	st. / Pallet
HZ2VTG060080	5410439076586	6	80	46	11,6	T 30	20	3	50	1500
HZ2VTG060090	5410439076579	6	90	61	11,6	T 30	20	3	50	1500
HZ2VTG060100	5410439076562	6	100	61	11,6	T 30	20	3	50	1500
HZ2VTG060110	5410439076555	6	110	68	11,6	T 30	20	3	50	1500
HZ2VTG060120	5410439076548	6	120	68	11,6	T 30	20	3	50	1500
HZ2VTG060130	5410439076531	6	130	68	11,6	T 30	20	1	50	1500
HZ2VTG060140	5410439076524	6	140	68	11,6	T 30	20	1	50	1500
HZ2VTG060150	5410439077125	6	150	68	11,6	T 30	20	1	32	960
HZ2VTG060160	5410439076517	6	160	68	11,6	T 30	20	1	32	960
HZ2VTG060180	5410439077132	6	180	68	11,6	T 30	20	1	16	480
HZ2VTG060200	5410439077149	6	200	68	11,6	T 30	20	1	32	960

HA EVTG IN BLISTER

The wood construction screw with partial thread and countersunk head

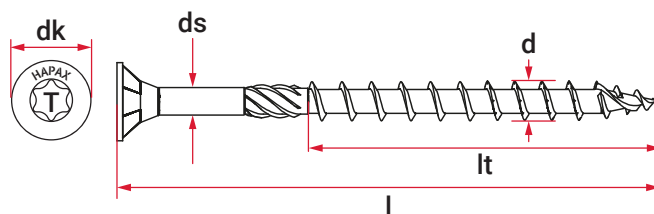

ETA 20/0787 - Screws for use in timber construction
DoPn° - 20-0787-01



Art. ref.	EAN code	d [mm]	l [mm]	lt [mm]	dk [mm]	Recess type	pcs / Blist.	blist. / Box min. sales quantity	blist. / Outer carton	st. / Pallet
HZ2VTG080080	5410439077040	8	80	48	14,5	T 40	10	3	16	480
HZ2VTG080100	5410439077057	8	100	60	14,5	T 40	10	3	16	480
HZ2VTG080120	5410439077064	8	120	75	14,5	T 40	10	3	50	1500
HZ2VTG080140	5410439077071	8	140	80	14,5	T 40	10	1	50	1500
HZ2VTG080160	5410439077088	8	160	90	14,5	T 40	10	1	50	1500
HZ2VTG080180	5410439077095	8	180	100	14,5	T 40	10	1	32	960
HZ2VTG080200	5410439077101	8	200	100	14,5	T 40	10	1	32	960

HAETTG IN BLISTER

The wood construction screw with partial thread and flange head

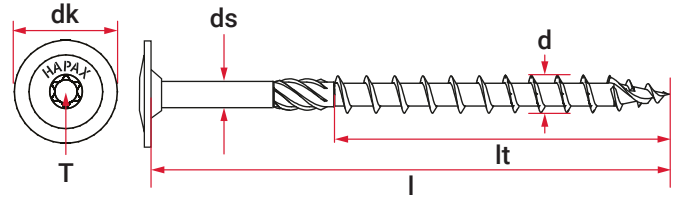

ETA 20/0787 - Screws for use in timber construction
DoPn° - 20-0787-01



Art. ref.	EAN code	d [mm]	l [mm]	lt [mm]	dk [mm]	Recess type	pcs / Blist.	blist. / Box min. sales quantity	blist. / Outer carton	st. / Pallet
HZ2TTG060030	5410439076890	6	30		14	T 30	15	6	32	960
HZ2TTG060040	5410439076906	6	40	24	14	T 30	15	6	32	960
HZ2TTG060050	5410439076913	6	50	30	14	T 30	15	6	72	3168
HZ2TTG060060	5410439076869	6	60	36	14	T 30	15	6	72	3168
HZ2TTG060070	5410439076920	6	70	42	14	T 30	15	3	72	3168
HZ2TTG060080	5410439076852	6	80	48	14	T 30	15	3	72	3168
HZ2TTG060100	5410439076845	6	100	60	14	T 30	15	3	72	3168
HZ2TTG060120	5410439076937	6	120	75	14	T 30	10	3	72	3168
HZ2TTG060140	5410439076944	6	140	80	14	T 30	10	1	72	3168
HZ2TTG060160	5410439076951	6	160	90	14	T 30	10	1	72	3168
HZ2TTG060180	5410439076968	6	180	100	14	T 30	10	1	72	3168
HZ2TTG060200	5410439076975	6	200	100	14	T 30	10	1	72	3168
HZ2TTG080040	5410439076982	8	40	24	21	T 40	10	6	72	3168
HZ2TTG080050	5410439076999	8	50	30	21	T 40	10	3	72	3168
HZ2TTG080060	5410439076838	8	60	36	21	T 40	10	1	72	3168
HZ2TTG080080	5410439076821	8	80	48	21	T 40	10	1	72	3168
HZ2TTG080100	5410439076814	8	100	60	21	T 40	10	1	72	3168
HZ2TTG080120	5410439076807	8	120	75	21	T 40	10	1	72	3168
HZ2TTG080140	5410439077002	8	140	80	21	T 40	10	1	72	3168
HZ2TTG080160	5410439077019	8	160	90	21	T 40	10	1	72	3168
HZ2TTG080180	5410439077026	8	180	100	21	T 40	10	1	72	3168
HZ2TTG080200	5410439077033	8	200	100	21	T 40	10	1	72	3168

Packer shims

HAP051

Ideal for quick filling and levelling of small heights



Art. ref.	EAN code	d [mm]	w [mm]	l [mm]	Max. weight	pcs / Blister
HAP051N0000100095A	5410439480574	1	22	95	300 kg	20
HAP051N0000200095A	5410439480598	2	22	95	300 kg	20
HAP051N0000300095A	5410439480611	3	22	95	300 kg	20
HAP051N0000400095A	5410439480635	4	22	95	300 kg	20
HAP051N0000500095A	5410439480659	5	22	95	300 kg	20
HAP051N0000600095A	5410439481496	1-2-3-4-5	22	95	300 kg	50

Hanger shims

HAP052

Ideal for filling and levelling wooden structures



Art. ref.	EAN code	d [mm]	w [mm]	l [mm]	pcs / Blister
HAP052N0000100055A	5410439480673	1	40	55	20
HAP052N0000200055A	5410439480697	2	40	55	20
HAP052N0000300055A	5410439480710	3	40	55	20
HAP052N0000400055A	5410439480734	4	40	55	20
HAP052N0000500055A	5410439480758	5	40	55	20
HAP052N0000600055A	5410439481526	1-2-3-4-5	40	55	50

Interlocking wedges

HAP053

Ideal for laying wooden floors



Art. ref.	EAN code	h [mm]	w [mm]	l [mm]	Max. weight	pcs / Blister
HAP053N0000100055A	5410439480772	14	30	90	300 kg	8
HAP053N0000200055A	5410439480796	15	43	95	300 kg	6
HAP053N0000300055A	5410439480819	22	43	150	300 kg	4

Packer shims

HAP051

Ideal for quick filling and levelling of small heights



Art. ref.	EAN code	d [mm]	w [mm]	l [mm]	Max. weight	pcs / Bag
HAP051N00010000955	5410439480871	1	22	95	300 kg	100
HAP051N00020000955	5410439480888	2	22	95	300 kg	100
HAP051N00030000955	5410439480895	3	22	95	300 kg	100
HAP051N00040000955	5410439480901	4	22	95	300 kg	100
HAP051N00050000955	5410439480918	5	22	95	300 kg	100



Red Hapax display



Art. ref.	d [mm]	l [mm]	h [mm]	pcs
DISPLAYHAPAXNL	660	800	1600	1
DISPLAYHAPAXFR	660	800	1600	1

Wooden Hapax display for demonstrations



Art. ref.	d [mm]	l [mm]	h [mm]	pcs
DISPLAY003NL	800	1200	1600	1
DISPLAY003FR	800	1200	1600	1



At pgb-Europe,
we are committed
to green energy
every day.

CURIOUS ?
Follow us
on LinkedIn,
Instagram,
Facebook
& Youtube

Contact

pgb-Europe
Logistics centre

Gontrode Heirweg 170
9090 Melle
Belgium
T: +32 9 272 70 70
F: +32 9 272 70 99
info@pgb-europe.com

www.pgb-europe.com

pgb-Polska
Production plant

Ul. Fryderyka Wilhelma Redena 3
41 - 807 Zabrze
Polska
T: +48 (32) 330 26 10
F: +48 (32) 330 26 20
biuro@pgb-polska.com

www.pgb-polska.com

pgb-France
Sales office

25 Rue du Champ des Oiseaux
59230 Saint-Amand-les-Eaux
France
T: +33 (0)3 27 21 56 80
F: +33 (0)3 27 30 31 16
info@pgb-france.com

www.pgb-france.com

Quality by **pgb**